

INSTRUCTION MANUAL

Battery-operated hydraulic Cutting Tool

CutMax-C45



Original instruction manual
Ident-No.: 72634500-BA
Stand: 08/2023 / Revision: 05/2026

- CutMax-C45 Ma (suitable for Makita batteries LXT)
- CutMax-C45 Bo (suitable for Bosch batteries PRO)
- CutMax-C45 Hi (suitable for Hilti batteries CPC)
- CutMax-C45 HiN (suitable for Hilti batteries Nuron)
- CutMax-C45 Mi (suitable for Milwaukee batteries M18)

Holger Clasen GmbH & Co. KG
Alsterdorfer Straße 228
22297 Hamburg, Germany
Tel. +49 40 511 28-0
info@holger-clasen.de
www.holger-clasen.de

Content

1	General Information	3
2	General Safety Information.....	5
3	Product Description	8
4	Technical Data	12
5	Commissioning	14
6	Operation	16
7	Troubleshooting	21
8	Maintenance and Service.....	22
9	Disposal.....	23
10	Accessories	25
11	Declaration of Conformity.....	28

Thank you for placing your trust in us by purchasing this tool.

1 General Information

We hereby confirm that the tool described in this instruction manual complies with the basic safety and health requirements pursuant to the EC Machinery Directive 2006/42/EC, the EMC Directive 2014/30/EU and the RoHS Directive 2011/65/EU relating to electromagnetic compatibility.

Keep this instruction manual in a place that all users of the tool are familiar with and can access easily. Read this manual carefully before using, maintaining, repairing or disposing of the tool. Make sure that you clearly understand the instructions and symbols explained in this manual or attached to any tools.

You can prevent accidents by adhering to the following basic safety advice pursuant to the EC Machinery Directive 2006/42/EC and the regulations for hand-operated tools. In any case inform yourself about and comply with the accident prevention regulations applicable in your country.

Do not remove existing labels and stickers, especially those containing legally required information.

Upon receiving the tool, make sure that the packaging is intact and the tool did not suffer any transportation damage. In case of damage, please contact Holger Clasen GmbH & Co. KG's customer service at +49 40 511 28-0. Keep the packaging.

1.1 Manufacturer's Warranty

If operated correctly and if the required service intervals are adhered to, we grant a warranty of 24 months beginning as of the day of delivery unless legal regulations require other warranties.

1.2 Disclaimer of Warranty

The product is designed exclusively for the intended use described in this documentation. Provided that the technical specifications are complied with and the prescribed maintenance and servicing measures are carried out, the product is intended for reliable continuous operation.

Safe operation requires compliance with all safety, operating, and maintenance instructions as well as with all applicable statutory regulations.

Any use other than the intended use, overloading, improper handling, failure to perform required maintenance, or unauthorized modifications may, to the extent permitted by law, result in the exclusion of liability and warranty claims.

The product is subject to natural wear and tear. Wear parts are therefore excluded from warranty and guarantee coverage unless a verifiable material or manufacturing defect can be demonstrated.

1.3 Symbols



WARNING!



Danger of hand injuries



Please read the instruction manual



Please wear safety goggles



Please wear safety shoes



Please wear protective clothes



Don't dispose of in residual waste



<p>CutMax-C45 Ma Force 70 kN Width max. Ø 45 mm Input 18 V DC/600 W Built 2025 holger-clasen.de</p>		<p>CutMax-C45 Bo Force 70 kN Width max. Ø 45 mm Input 18 V DC/600 W Built 2025 holger-clasen.de</p>		<p>CutMax-C45 Hi Force 70 kN Width max. Ø 45 mm Input 22 V DC/720 W Built 2025 holger-clasen.de</p>		<p>CutMax-C45 HiN Force 70 kN Width max. Ø 45 mm Input 22 V DC/720 W Built 2025 holger-clasen.de</p>		<p>CutMax-C45 Mi Force 70 kN Width max. Ø 45 mm Input 18 V DC/600 W Built 2025 holger-clasen.de</p>	
---	--	---	--	---	--	--	--	---	--

Serial No./Built: In the battery shaft/at the head

2 General Safety Information

WARNING

Danger due to overheating, breakage or electric shock of the battery.

The tool, the battery and the charger are matched components.

- ▶ This tool may only be operated with a suitable rechargeable battery.
- ▶ Charge the battery with the appropriate charger.
- ▶ Only use the original battery and charger.

Charge the battery in accordance with the instructions.

- ▶ Connect the charger to a power source with suitable power specifications.
- ▶ Do not use a DC or motor-driven generator.
- ▶ Unplug the charger after charging is complete.
- ▶ Do not use the charger in the rain.

Pay attention to the temperature of the battery, the charger and the environment.

- ▶ Do not charge the battery at temperatures below 0° or above +40° C.

Ensure sufficient ventilation of the battery during the charging process.

- ▶ Do not cover the battery and charger during charging.

Do not short-circuit the contact surfaces of the battery.

Failure to do so may result in bursting of the battery and leakage of hazardous materials.

- ▶ Secure the contact surfaces of the battery with the cover provided for this purpose.
- ▶ Do not store the battery without the cover together with metal parts such as nails, screws, etc.

Do not place the battery in a fire.

Failure to do so may result in bursting of the battery and leakage of hazardous materials.

Hydraulic fluid under pressure.

Escaping fluid under pressure can cause severe injury or death.

- ▶ If injure, seek medical attention immediately.

Danger due to electric shock.

The tool is not insulated in contact with electrically charged parts.

- ▶ Never work live strands / cables!
- ▶ When using the device on or near live wires, wear suitable personal protective equipment
- ▶ Do not touch the power plug or the battery with wet hands.

Exposed working area.

Danger of hand injury.

- ▶ Never reach into the running tool.

Influence by electromagnetic waves

The functionality of pacemakers can be influenced by electromagnetic waves emitted.

- ▶ Keep the tool at least 15 cm or more away from the pacemaker.

Risk of injury to the hand

Prevent the tool from starting up unintentionally

- ▶ Always move the piston to the starting position after use or before changing parts and remove the battery.
- ▶ Keep your fingers away from the trigger when transporting the tool.
- ▶ Secure the trigger.

Danger due to inhalation of dust

Depending on work environment dust hazardous to health may be generated during machining.

- ▶ Wear a protective mask during dusty operation.

Danger of eye injuries

Material can fly around.

- ▶ Wear protective goggles. Normal goggles do not provide sufficient protection.

Danger to persons in the vicinity due to breakage

During operation, overload/material fatigue can cause damage to the head. Parts flying around can cause injuries.

- ▶ Do not point the head of the tool at persons in your environment during operation.

Failure to observe the following instructions may result in property damage or accidents:

Use the tool within the scope of its intended use.

Do not overload the tool. Overloading can lead to blocking, excessive heat generation and ignition.

Keep handles and contact surfaces dry, clean and oil-free. Slippery surfaces reduce tool control and can lead to accidents in unexpected situations.

Refrain from any working method that could endanger safety.

Only use attachments and accessories for the work intended for them.

Do not make any modifications to the tool. Ensure a fatigue-free working position.

Remain attentive when working with high concentration.

Do not operate the tool if you are in poor physical condition.

Do not operate the tool under the influence of alcohol.

When using the device on or near live wires, wear suitable personal protective equipment.

Do not touch the power plug or the battery with wet hands.

3 Product Description



A1

A1: Beschreibung

- 1 Cutting Blade
- 2 Snap Lock
- 3 Eyelet for Carrying Strap
- 4 Cutting head, 180° rotatable
- 5 Lash for Carrying Strap
- 6 Lash for Carrying Strap
- 7 Type Label
- 8 Lash for Carrying Strap
- 9 Accumulator (not included)
- 10 Locking Button
- 11 LED
- 12 Release Button
- 13 Return Button
- 14 Counter Blade
- A Bump Protection
- B Switching between automatic and manual return

3.1 Intended Use

This battery-operated hydraulic tool has been designed for cutting Cu- and Al-strand/cable as well as ACSR (overhead lines) up to \varnothing 45 mm, also round material and round steel according to the application table (chapter 4.1). For other applications, please contact Holger Clasen GmbH & Co. KG. The tool has been designed to be connected to an accumulator according to technical data.

Although this tool has been designed according to the state-of-the-art and recognized safety requirements, its use may constitute a potential threat to the life and limbs of its user or third parties or damage the tool or other material assets. Use or application for purposes other than those intended by the manufacturer will be considered improper. Holger Clasen GmbH & Co. KG will not be liable for damage resulting from improper use. The operator works at his own risk.

3.2 Expected misuse

This tool is not suitable for cutting high-tensile or hardened steel, which will damage and possibly break the knife. This tool is not suitable for cutting fine/very fine stranded conductors, this will cause the blades to jam.

3.3 Qualification

This tool may only be used by qualified personnel who have read this safety advice and instruction manual.

3.4 Operator Protection



Danger due to chips flying around.

Wear protective goggles.

Standard glasses do not provide sufficient protection and are no proper substitution for safety eyewear.



Danger of drawing in of clothes and hair.

Wear protective clothes.

Loose or baggy clothes increase the risk of catching or winding on moving parts.

- Wear tight-fitting work clothing.
- Do not wear long hair open. Wear it well covered.
- Do not wear rings, chains or other jewellery.

**Risk of crushing/sliding.**

Wear protective shoes.

Make sure to stand firmly.

3.5 Workplace

Do not use the tool in environments where there is a risk of fire or explosion.
Keep your workplace clean.

Keep children and unauthorized people away from your work environment.
Ensure that there is sufficient lighting at the workplace.

Before switching on the tool, make sure that no one is endangered
by the starting tool.

Protect the tool from moisture, water, extreme heat / cold, chemical solutions
and gases.

Do not use the tool, the battery and the charger in the rain or in a wet environment
or a wet environment. Do not charge the battery there either.

Protect the battery tool from falls or impacts.

3.6 Temperature Range

The possible working range of the tool is in the temperature range from
-20° C to +40° C.

The recommended working range is in the temperature range from -5° C to +40° C.
Temperatures between -20° C and -5° C leads to changes in the flow properties of
the hydraulic oil.

To ensure unrestricted use, we recommend storing the tool for one hour in a room
with a temperature of +10 to +25°C.

3.7 Transport and Storage

Ensure dry storage to protect the tool from rust.

Clean the tool before / after use and before storage.

Secure the contact surfaces of the battery with the cover provided.

If the tool is transported to another factory department or location, make sure that
the tool and/or accessories are not damaged. Pack the tool accordingly.

Store the tool properly when not in use.

Store the tool in a place inaccessible to unauthorized persons.

Do not store the tool and battery in a place where the temperature may rise to +40°C or more (in a metal box, in a car in summer, etc.). Overheating may cause damage, smoke generation or ignition.

⚠ Due to the high energy density of rechargeable batteries, there is a higher risk potential, especially when shipping used rechargeable batteries.

One of the greatest risk factors when transporting rechargeable batteries or battery-powered devices is the danger of short circuits if the battery terminals meet other rechargeable batteries, metal objects or other conductive material.

If the battery is inserted in the tool, the battery terminals are secured.

If they are stored separately or shipped individually, secure storage must be ensured. A possible short circuit and damage to the connection terminals must be prevented. For this purpose, the battery terminals must be secured with a non-conductive material (e.g. adhesive tape) or the contact protection cap. Batteries must be adequately protected against movement.

Special protective measures must be taken when shipping in airplanes or batteries over 100 Wh.

Notice IATA Packing instruction 965 Part 2 for lithium-ion-batteries. If package/battery is damaged, batteries must be quarantined, inspected and repacked.

Attention: Following the IATA Packing instructions batteries are delivered on 30 % charge level. Please completely charge the battery before usage with the recommended battery charger.

Observe the manufacturer delivery information (download):

Makita:

<https://www.holger-clasen.de/bl1850b-makita-akku-lithium-ionen-18-v/79300115>

Bosch:

<https://www.holger-clasen.de/en/bosch-battery-lithium-ion-18-v/79300122>

4 Technical Data

Item	CutMax-C45
Cutting Force	70 kN
Opening Width	45 mm
Battery Voltage	18 V / Hilti (Hi/HiN): 22 V
Weight*	6.1 kg
Dimensions* L x W x H	444 x 92 x 307 mm
Head	Closed, 180° rotatable
Sound Pressure Level L_{pa}	77.3 dB(A)
Sound Power Level L_{WA}	88.3 dB(A)
Vibration _{ah} Handle	0.433 m/s ²
Uncertainty K	0.047 m/s ²

* without battery

MasterBase technology offers the following battery options:

Item	Item No.	Suitable for batteries
CutMax-C45 Ma	72634500	Makita 18 V Li-Ionen LXT
CutMax-C45-Set Ma **	72644500	Makita 18 V Li-Ionen LXT
CutMax-C45 Bo	72674600	Bosch 18 V Li-Ionen PRO
CutMax-C45-Set Bo ***	72684600	Bosch 18 V Li-Ionen PRO
CutMax-C45 Hi	72674500	Hilti 22 V Li-Ionen CPC
CutMax-C45 HiN	72070100	Hilti 22 V Li-Ionen Nuron
CutMax-C45 Mi	72067700	Milwaukee 18 V Li-Ionen M18

**Scope of Delivery Set:

CutMax-C45 Ma (Item No. 72634500),
 Li-Ion Battery Makita BL1850B, 18 V / 5 Ah (Item No. 79300115),
 Battery Charger DC18RC (Item No. 79300120),
 Carrying Strap TR-25-2 (Item No. 07775001),
 Transportation Case KOFF-K CM-C3-C11 (Item No. 79500112)

*****Scope of Delivery Set:**

CutMax-C45 Bo (Item No. 72674600),
Bosch Li-Ion Battery PRO GBA 18V 5.0 Ah (Item No. 79300122),
Bosch Battery Charger PRO GAL 1880CV (Item No. 79300123),
Carrying Strap TR-25-2 (Item No. 07775001),
Transportation Case KOFF-K CM-C3-C11 (Item No. 79500112)

Noise information and vibration values in accordance with EN 62841-1





The sound pressure and vibration values given in these instructions were measured in accordance with a standardized test and can be used to compare one power tool with another. They can also be used for a preliminary assessment of exposure.

The data given represent the main applications of the power tool. However, if the power tool is used for different applications, with different accessory tools, or is poorly maintained, the data can vary. This can significantly increase exposure over the total working period.

An accurate estimation of exposure should also take into account the times when the tool is switched off, or when it is running but not actually being used for a job. This can significantly reduce exposure over the total working period.

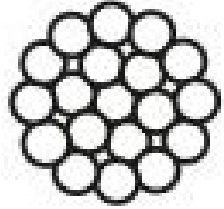
Identify additional safety measures to protect the operator from the effects of noise and/or vibration, for example: maintaining the power tool and accessory tools, keeping the hands warm, organization of work patterns.

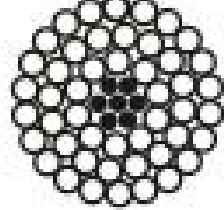
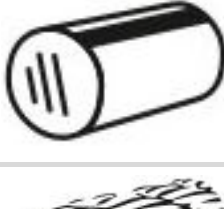
4.1 Cutting Range Table

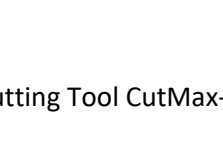
Anwendung <i>Application</i>	Max. Schneiddurchmesser <i>Max. Cutting Diameter</i>	
Cu Seil <i>Cu Strand</i>	Ø 45 mm	
Al Seil <i>Al Strand</i>	Ø 45 mm	
Cu Energiekabel <i>Cu Energy Cable</i>	Ø 45 mm	
Al Energiekabel <i>Al Energy Cable</i>	Ø 45 mm	
Cu Rundmaterial <i>Cu Round Material</i>	Ø 22 mm	
Al Rundmaterial <i>Al Round Material</i>	Ø 20 mm	
Al/St-Seil <i>ACSR</i>	Ø 45 mm (Stahlanteil/ <i>Steel part</i> : 79 mm ² , z.B./ <i>e.g.</i> 450/40)	
Rundstahl <i>Round Steel</i>	Ø 20 mm	
Drahtseil <i>Wire Rope</i>	6x7: Ø 22 mm 6x12: Ø 25 mm 6x19: Ø 25 mm	
Abspanndraht <i>Guy Wire</i>	1x17: Ø 20 mm 1x19: Ø 20 mm	
Bewehrungsstahl <i>Reinforcing Rod</i>	Ø 16 mm	

5 Commissioning

The tool set includes a tool, a battery and a matching charger.

Charge the battery using only this charger.

Fully charge the battery before using it for the first time.

Make sure that the accumulator is charged before each use.

Reload if necessary.

Observe the manufacturer manual (Download):

Makita:

<https://www.holger-clasen.de/bl1850b-makita-akku-lithium-ionen-18-v/79300115>

<https://www.holger-clasen.de/en/dc18rc-makita-quick-charger/79300120>

Bosch:

<https://www.holger-clasen.de/en/bosch-battery-lithium-ion-18-v/79300122>

<https://www.holger-clasen.de/en/bosch-quick-charger/79300123>

6 Operation

⚠ WARNING

Exposed Cutting Blades.

Danger of hand injuries.

- ▶ Never reach into the running tool.

DO NOT use in continuous operation because of overheating the motor.

Allow the tool to cool down in good time for a few minutes.

6.1 LED-Workplace Illumination

⚠ WARNING

Very bright light source.

Danger due to damage to the eyes during prolonged eye contact.

- ▶ Do not look directly into the LED.



B1

B1: Press the forward button (12).

The LED for working field illumination switches on.

The LED remains lit until 10 seconds after the button is released.

6.2 Inserting / Removing the Battery

Check the battery charge level.
To do this, press the test button.

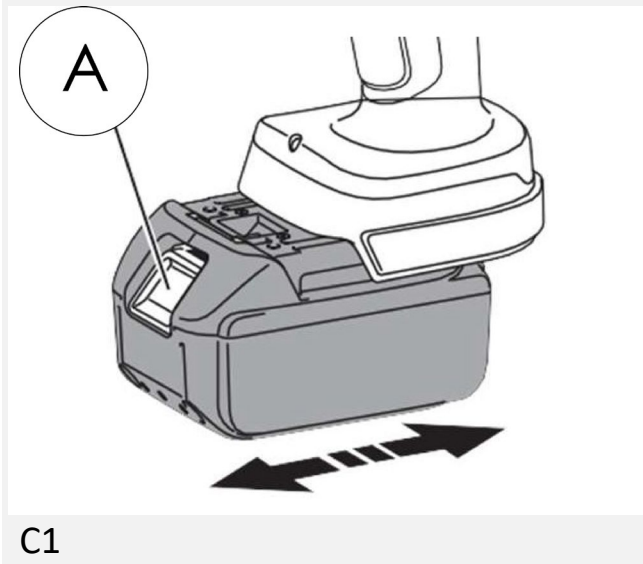

C1:

Inserting Battery:

Push the battery firmly into the battery holder.
The locking button (A) must click into place.
Check that the battery is securely locked in place.

Removing the battery:

Press the locking button (A) on the battery.
Hold the locking button down.
Pull the battery out of the tool.

6.3 Select manual/automatic Return

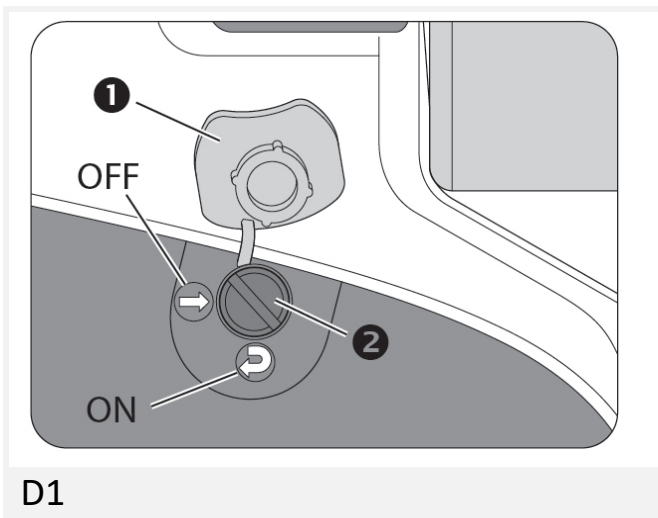

The tool is set to automatic return upon delivery.

Use a screwdriver to open the rubber cover ❶.

If the slot ❷ points to the **curved arrow**, **automatic return** is activated.

If the slot ❷ points to the **straight arrow**, **manual return** is set.

The user controls the forward and reverse functions using the buttons.

The changeover is made by turning a screwdriver a quarter turn.

Close the cover again.

Manual Return:

Press the forward button (12) to process the material.

Keep the forward button pressed.

The tool stops when it reaches maximum force.

Move the piston to its starting position/desired position by pressing the reverse button (8).

Automatic Return:

Press the forward button (12) to process the material.

The tool stops when the maximum force is reached and the piston automatically returns to its starting position.

By pressing the forward button again, you can interrupt the return movement and the piston will stop at the **desired position**.

6.4 Cutting

Check the head and the control buttons for function and damage.

If there is obvious damage, do not put it into operation.

Move the cutting blade to its starting position by using the return lever (13).

NOTICE

Non-observance of the advice will lead to damage and even to breakage of the blades.



Open the Cutting Blade:

Pull the snap lock, the counter blade folds down. Position the material to be cut. Fold back the counter blade. Insert the snap lock completely.

Locking properly (E1+E2):

Make sure that the locking unit is closed completely.

Alignment of the tool to cable (E3+E4):

Position the tool so that it cuts axial to the cable.

Lever lock (E5) – Protection against accidental start-up:

For safety reasons, the forward drive switch is fitted with a lever lock. It can be engaged in both directions (red arrows). To release it, move the lever lock to the central position.

Cutting:

Press the forward button (12).
Keep the forward button pressed until the cable is cut completely.

In the case of **manual return**, move the cutting blade to its starting position by pressing the return button (13).

In the case of **automatic return**, this is done after reaching the maximum force or loosening the forward button.

Remove any chips and metal left on the blades before cutting again.

7 Troubleshooting

If the tool is colder than -5°C , store it in a room with a temperature of $+10$ to $+25^{\circ}\text{C}$ for at least one hour to allow the tool to warm up to room temperature again. At temperatures between -20°C and -5°C , the flow properties of the hydraulic oil change.

Error	Cause	Solution
The tool does not work.	The battery is not charged.	Recharge the battery.
	The battery is not inserted correctly.	Insert the battery correctly.
	The contacts between the battery and the tool are dirty.	Clean the contacts.
	Fault in the hydraulic system (e.g. air).	Have the manufacturer inspect the tool.
The blades do not move forward or back.	The blades are dirty.	Remove chips and metal left on the blades.
	The blades and the material to be cut are twisted.	Have the manufacturer inspect the tool.
	Wear of the return spring.	Have the manufacturer inspect the tool.
Material is not cut.	Check the application / the material to be cut.	Wrong application.
	The material to be cut is too cold. *	Warm up the material to be cut.

* At temperatures below 10°C , the cutting properties of electrical conductors change. Cuts may not be possible even if they are within the range of intended use.

8 Maintenance and Service

Task	Period	Maintenance by
Clean and grease movable parts. ► Use machine care oil Not authorised: chemicals, water or wet clothes	Daily	User
Inspection for damage and defects	Daily	User
Maintenance: ▪ Tool ▪ Operating pressure ▪ Hydraulic oil ▪ Blades	Every 12 months (approx. 10.000 work cycles)	Manufacturer

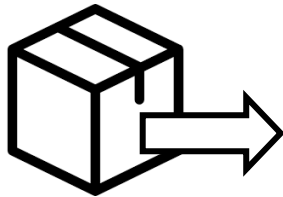

TSC Technik-Service-Center
 Alsterdorfer Straße 228
 22297 Hamburg, Germany
 Tel. +49 40 511 28-200
 service@holger-clasen.de
 www.holger-clasen.de

Only use the original hydraulic oil used by us.

The use of any other hydraulic oil may damage the tool or affect functionality.

Disassembly or modification of the tool by unqualified persons could cause accidents. Always allow qualified technicians only or the Technik-Service-Center (TSC) by Holger Clasen GmbH & Co. KG to carry out maintenance work. Use original spare parts by HOLGER CLASEN.

9 Disposal

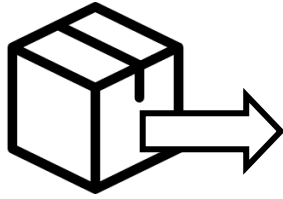

Holger Clasen GmbH & Co. KG
Alsterdorfer Straße 228
22297 Hamburg, Germany
Tel. +49 40 511 28-0
service@holger-clasen.de
www.holger-clasen.de

Do not dispose of the tool as a unit in residual waste.

Tool components can cause environmental damage!

Dispose of the tool in accordance with the scope of the European WEEE (2012/19/EU) and RoHS directives (2011/65/EU).

Rechargeable batteries must be disposed of in accordance with the Battery Directive (2023/1542/EU).

Improper disposal is punishable under the Environmental Liability Act!

In accordance with §19 ElektroG, Holger Clasen GmbH & Co. KG offers the following options for returning old appliances:

1. send in the old appliance with clear notification for disposal to the following drop-off address: **Holger Clasen GmbH & Co. KG, Alsterdorfer Straße 228, 22297 Hamburg, Germany.**
2. personal delivery of the old appliance to the above address.
3. chargeable commissioning of Holger Clasen GmbH & Co. KG to collect the old appliance. The end user is responsible for the proper packaging of the old appliance.

The owner of the waste equipment is responsible for the disposal of personal data in physical or digital form prior to handover.

The owner of the old appliance is responsible for the non-destructive separation or appropriate packaging of old batteries and accumulators in accordance with Section 10 (1) ElektroG, unless they are enclosed by the old appliance.

The battery, the circuit boards and other components must be disposed of separately in accordance with the environmental standards in force in the European Union or in your country. Send the tool to Holger Clasen GmbH & Co. KG for disposal.

Do not dispose of battery pack together with household waste material! In observance of the European Directive 2006/66/EC, on batteries and accumulators and waste batteries and accumulators and the implementation in accordance with national laws, batteries and battery pack(s) that have reached the end of their life must be collected separately and returned to an environmentally compatible recycling facility.

For the disposal of products from other manufacturers, please check their applicable disposal procedures.

For Makita and Bosch products, you will find disposal instructions in the download section of our website under the relevant products.

10 Accessories

Type		Description	Item No.
Case CutMax-C45 Ma / Bo / Mi	Koff-Km CM-C3-C11	Lightweight Plastic case with compartments for tool, two batteries and battery charger	79500112
Carrying Strap	TR-REC	Carrying strap for battery tools, strap 25 mm wide, 1 snap hook	07542106
	TR-25-2	Carrying strap for battery tools, strap 25 mm wide, 2 snap hooks	07755001
Spare Blades	450-01	Cutting Blade	07448018
	745-02	Counter Blade	07173021
Battery Makita*	BL1850B	Type: Lithium-Ion (90 Wh) Battery Voltage: 18 V Capacity: 5.0 Ah Dimensions: 115 x 75 x 67 mm Weight: 0.64 kg Charging Time: 45 min Charger: DC18RC	79300115
Battery Charger Makita	DC18RC	Input Voltage: 220 – 240 V, 50/60 Hz Weight: 0.90 kg Dimensions: 156 x 190 x 84 mm Charging Time BL1850B (5.0 Ah): 45 min	79300120
Battery Bosch	GBA 18V 5.0Ah	Type: Lithium-Ionen (90 Wh) Battery Voltage: 18 V Capacity: 5.0 Ah Dimensions: 74 x 114 x 56 mm Gewicht: 0.62 kg Charging Time: 80% / 28 min 100% / 45 min Charger: GAL 1880 CV	79300122

Type		Description	Item No.
Battery Charger Bosch	GAL 1880 CV	Input Voltage: 220 – 240 V, 50/60 Hz Charging Current: 8 A Weight: 0.70 kg Dimensions: 140 x 95 x 250 mm Charging Time GBA 18V 5 Ah: 100% / 45 min	79300123

* Optionally, other 18V Makita batteries can be used:
 BL1815N, BL1820B, BL1830B, BL1840B, BL1860B

EC DECLARATION OF CONFORMITY

We: **HOLGER CLASEN GmbH & Co. KG**
Alsterdorfer Straße 228
22297 Hamburg, Germany

in accordance with the following Directive(s)

2006/42/EG – The Machinery Directive
2014/30/EU – EMC Directive
2011/65/EU – RoHS Directive

hereby declare that,

Equipment: **Battery-operated hydraulic Cutting Tool**

Type: **CutMax-C45**

Serial number: _____

is in conformity with the applicable requirements of the following documents:

Machinery Directive: EN 62841-1:2015; 62841-2-8: 2016

EMC Directive: EMI: EN 61000-6-4: 2007+A1:2011

EMS: EN 61600-6-2: 2005

I hereby confirm that the equipment named above has been designed to comply with the relevant sections of the above referenced specifications. The unit complies with all applicable Essential Requirements of the Directive(s).

Hamburg, 01.09.2023

HOLGER CLASEN GmbH & Co. KG



Lennart Clasen (Managing Director)